

8 7 6 5 4 3 2 1

ZONE		REV.	DESCRIPTION	DATE	APPROVED
		A	Check-In	9/5/2018	MAM

REVISIONS

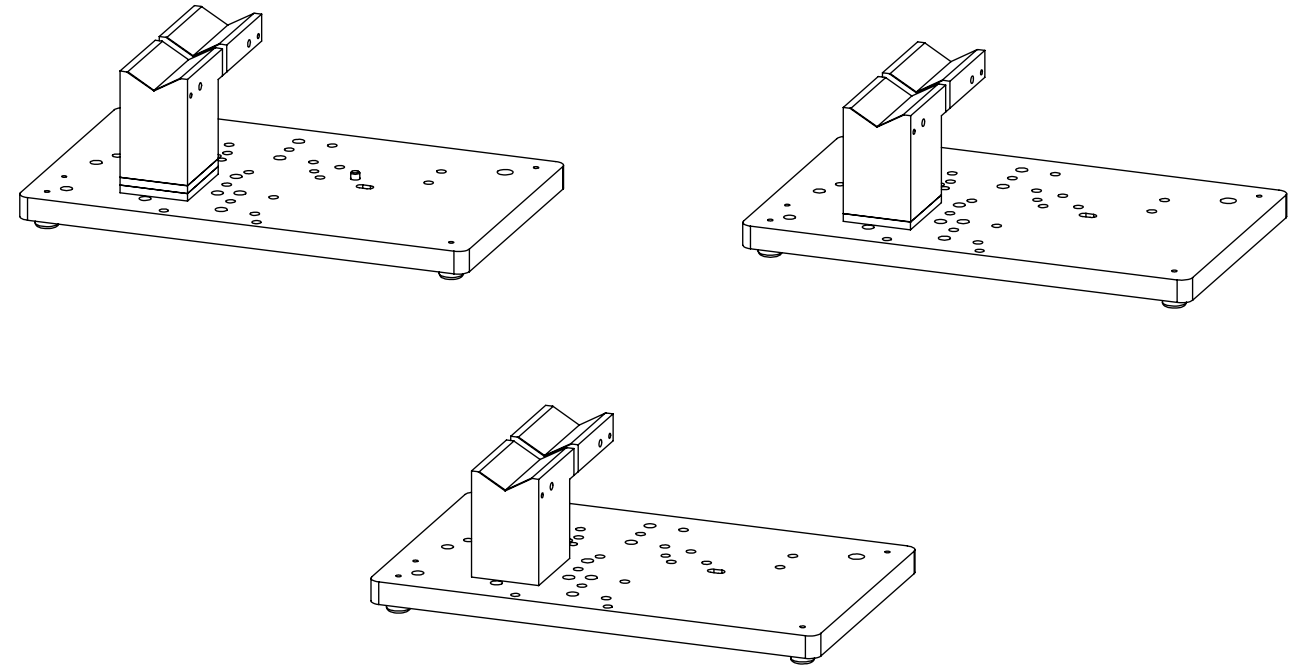

# AXION222 V-BLOCK FIXTURE, WHITE DELRIN OVERALLS

## INDEX

- (1) Cover Page
- (2) No Riser Fixture Dimensions
- (3) No Riser Mounted Dimensions
- (4) 1 Riser Fixture Dimensions
- (5) 1 Riser Mounted Dimensions
- (6) 2 Riser Fixture Dimensions
- (7) 2 Riser Mounted Dimensions

<b>GENERAL FINISH NOTE</b>		UNLESS OTHERWISE SPECIFIED:		NAME	DATE
<b>DE-BURR AND BREAK ALL SHARP EDGES BEFORE FINISH AND/OR SHIPPING</b>		DIMENSIONS ARE IN INCHES TOLERANCES: ANGLES ±.25° TWO PLACE DECIMAL ±0.010 THREE PLACE DECIMAL ±0.005 FOUR PLACE DECIMAL ±0.0005 UNMARKED FILLETS/CHAMFER .06 DE-BURR ALL PARTS		DRAWN BY:	EMM 11/4/2020
<b>PROPRIETARY AND CONFIDENTIAL</b>		INTERPRET GEOMETRIC TOLERANCING PER: ASME Y14.5			
THE INFORMATION CONTAINED IN THIS DRAWING IS THE SOLE PROPERTY OF LASERLINC, INC. ANY REPRODUCTION IN PART OR AS A WHOLE WITHOUT THE WRITTEN PERMISSION OF LASERLINC, INC. IS PROHIBITED.		MATERIAL		63 RA SURFACE FINISH ALL FEATURES MUST MEET SPECIFICATION AFTER PLATING BEFORE POWDER-COAT IF PLATED OR POWDER-COATED <b>SEE FINISH</b>	
		FINISH		TITLE: 0222-0001-21 AXION222 V-BLOCK FIXTURE, WHITE DELRIN OVERALLS	
		DO NOT SCALE DRAWING		SIZE <b>B</b>	DWG. NO. 0222-0001-21
				REV <b>A</b>	
				SCALE: 1:4	SHEET 1 OF 7



8 7 6 5 4 3 2 1

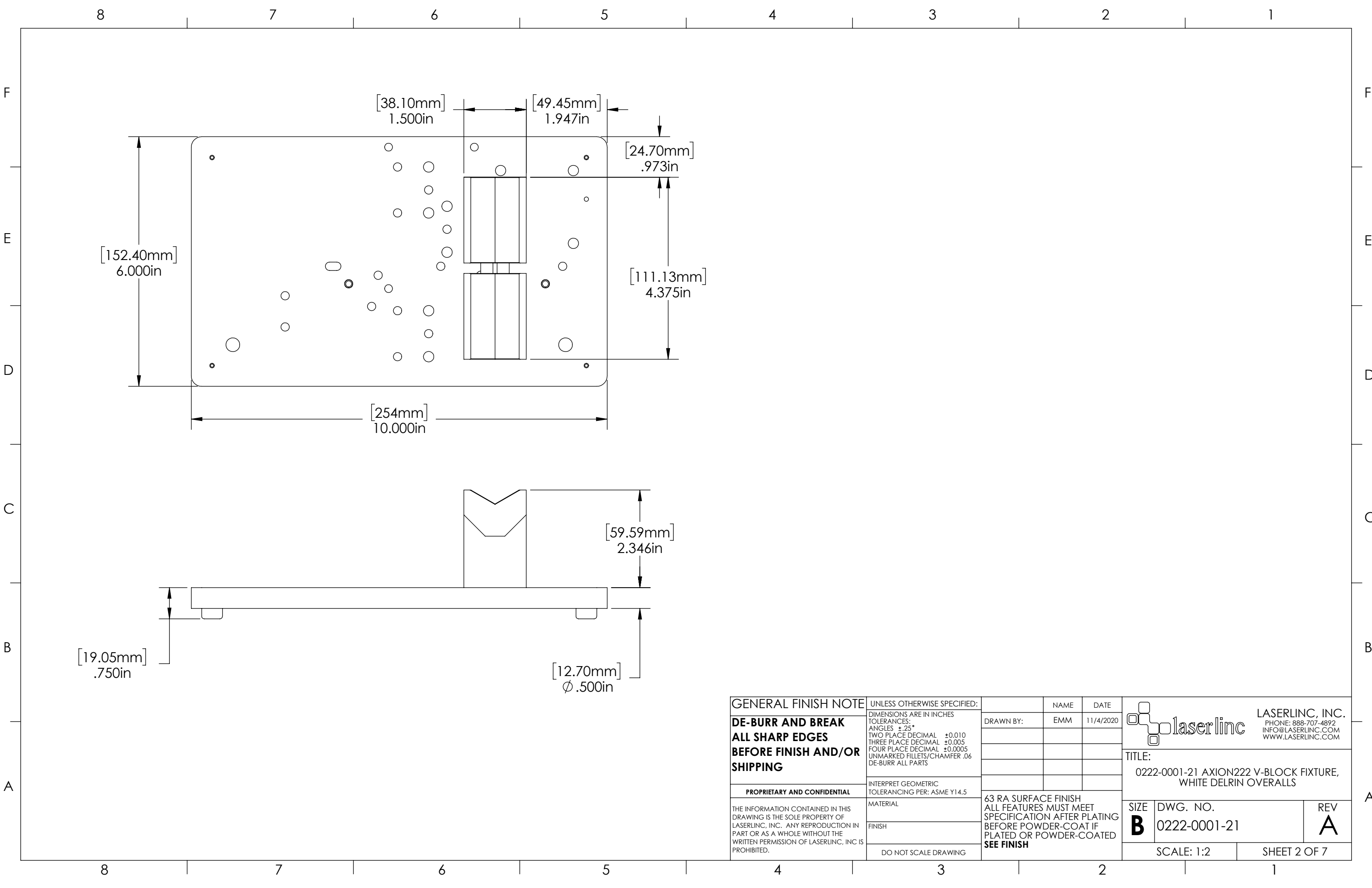

<b>GENERAL FINISH NOTE</b>		UNLESS OTHERWISE SPECIFIED:		NAME	DATE
<b>DE-BURR AND BREAK ALL SHARP EDGES BEFORE FINISH AND/OR SHIPPING</b>		DIMENSIONS ARE IN INCHES TOLERANCES: ANGLES ±.25° TWO PLACE DECIMAL ±0.010 THREE PLACE DECIMAL ±0.005 FOUR PLACE DECIMAL ±0.0005 UNMARKED FILLETS/CHAMFER .06 DE-BURR ALL PARTS		DRAWN BY:	EMM 11/4/2020
<b>PROPRIETARY AND CONFIDENTIAL</b>		INTERPRET GEOMETRIC TOLERANCING PER: ASME Y14.5			
THE INFORMATION CONTAINED IN THIS DRAWING IS THE SOLE PROPERTY OF LASERLINC, INC. ANY REPRODUCTION IN PART OR AS A WHOLE WITHOUT THE WRITTEN PERMISSION OF LASERLINC, INC. IS PROHIBITED.		MATERIAL		63 RA SURFACE FINISH ALL FEATURES MUST MEET SPECIFICATION AFTER PLATING BEFORE POWDER-COAT IF PLATED OR POWDER-COATED <b>SEE FINISH</b>	
		FINISH			
		DO NOT SCALE DRAWING		TITLE: 0222-0001-21 AXION222 V-BLOCK FIXTURE, WHITE DELRIN OVERALLS	
				SIZE <b>B</b>	DWG. NO. 0222-0001-21
				REV <b>A</b>	
				SCALE: 1:2 SHEET 2 OF 7	



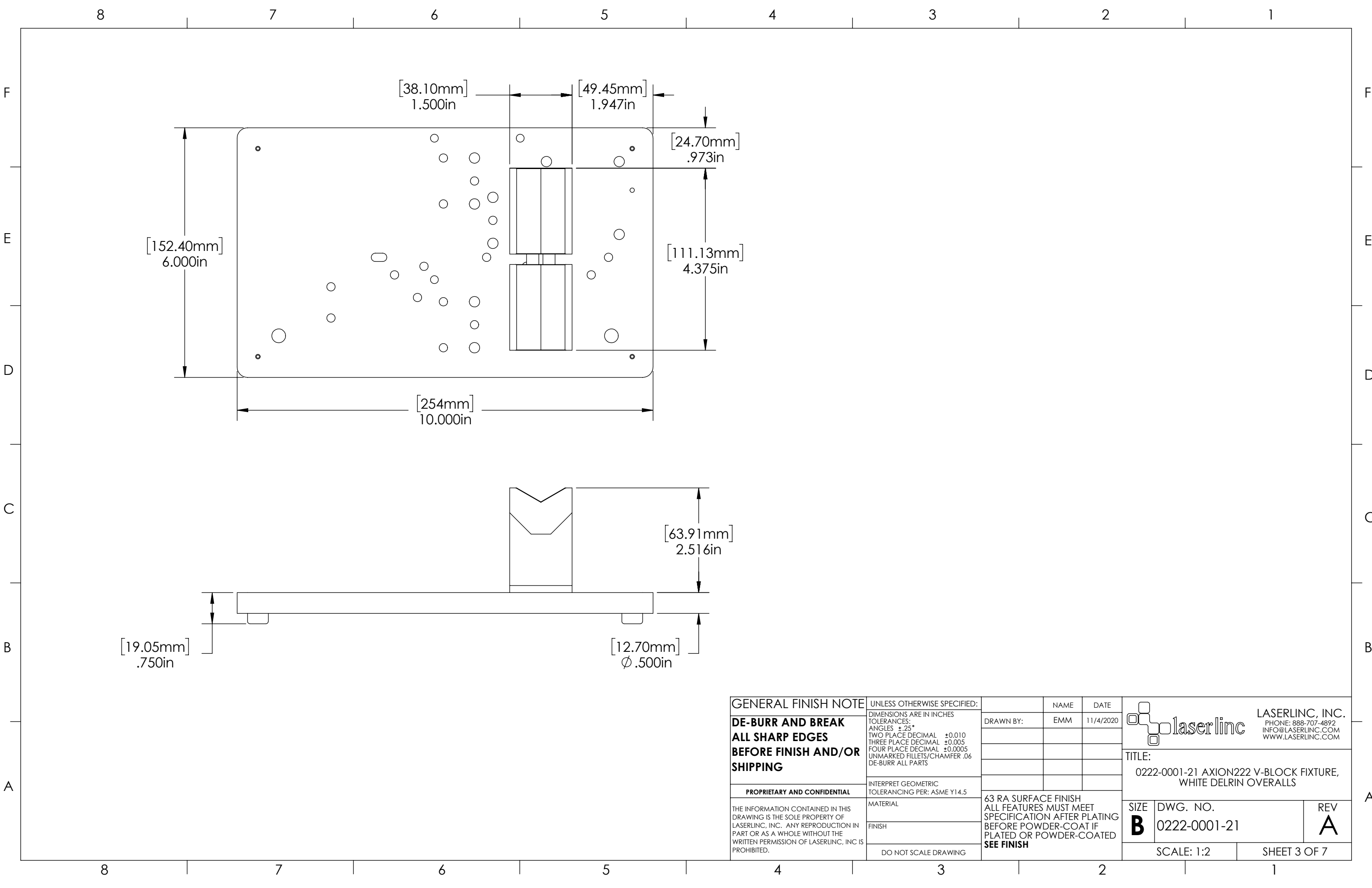

**GENERAL FINISH NOTE**  
**DE-BURR AND BREAK**  
**ALL SHARP EDGES**  
**BEFORE FINISH AND/OR**  
**SHIPPING**

UNLESS OTHERWISE SPECIFIED:  
 DIMENSIONS ARE IN INCHES  
 TOLERANCES:  
 ANGLES ±.25°  
 TWO PLACE DECIMAL ±0.010  
 THREE PLACE DECIMAL ±0.005  
 FOUR PLACE DECIMAL ±0.0005  
 UNMARKED FILLETS/CHAMFER .06  
 DE-BURR ALL PARTS

INTERPRET GEOMETRIC  
 TOLERANCING PER: ASME Y14.5

MATERIAL

FINISH

DO NOT SCALE DRAWING

DRAWN BY:		NAME	DATE
		EMM	11/4/2020
 <b>LASERLINC, INC.</b> PHONE: 888-707-4892 INFO@LASERLINC.COM WWW.LASERLINC.COM			
TITLE:			
0222-0001-21 AXION222 V-BLOCK FIXTURE, WHITE DELRIN OVERALLS			
SIZE	DWG. NO.	REV	
<b>B</b>	0222-0001-21	<b>A</b>	
SCALE: 1:2		SHEET 3 OF 7	

63 RA SURFACE FINISH  
 ALL FEATURES MUST MEET  
 SPECIFICATION AFTER PLATING  
 BEFORE POWDER-COAT IF  
 PLATED OR POWDER-COATED  
**SEE FINISH**

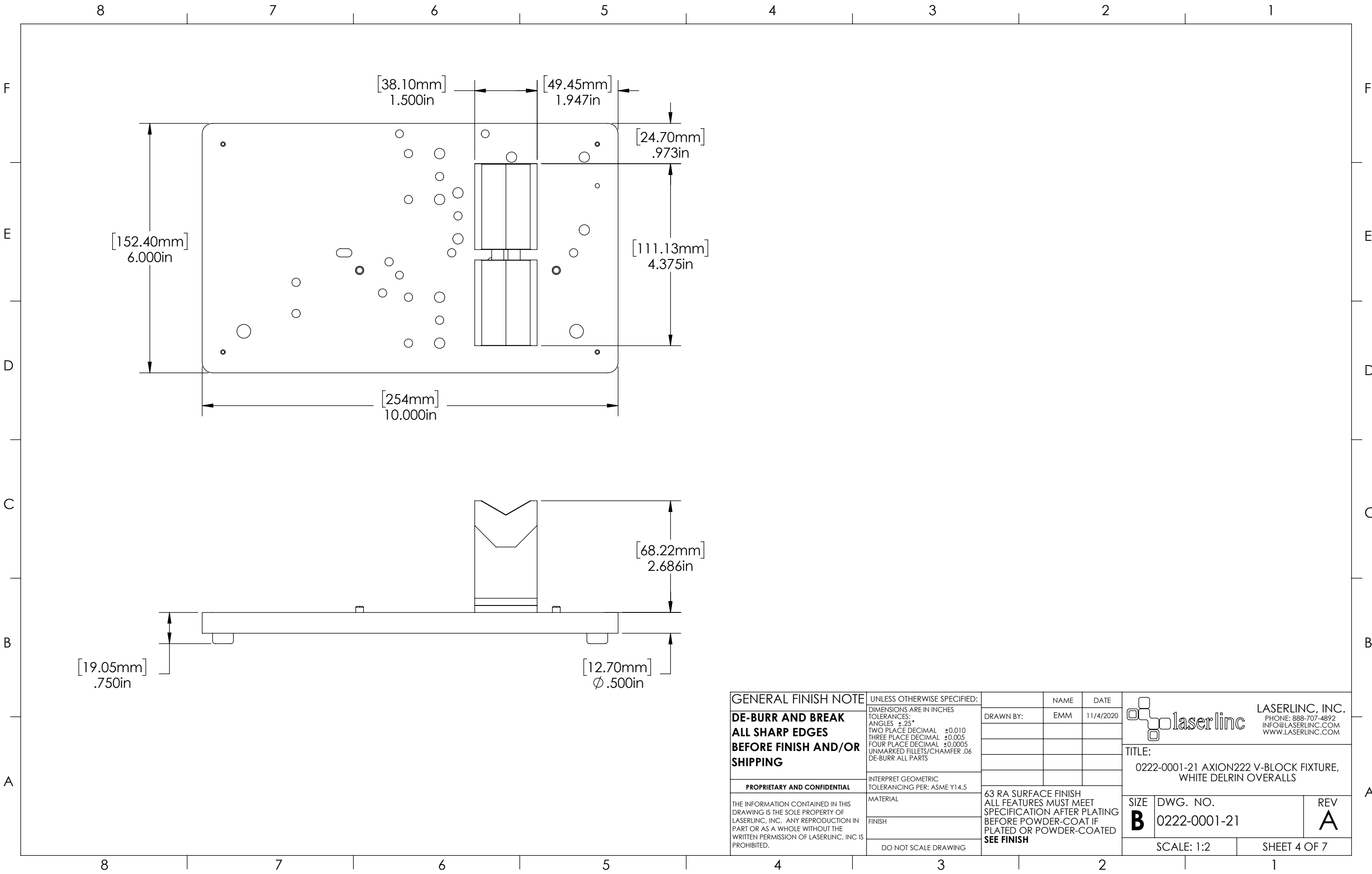

**GENERAL FINISH NOTE**  
**DE-BURR AND BREAK**  
**ALL SHARP EDGES**  
**BEFORE FINISH AND/OR**  
**SHIPPING**

UNLESS OTHERWISE SPECIFIED:  
 DIMENSIONS ARE IN INCHES  
 TOLERANCES:  
 ANGLES ±.25°  
 TWO PLACE DECIMAL ±0.010  
 THREE PLACE DECIMAL ±0.005  
 FOUR PLACE DECIMAL ±0.0005  
 UNMARKED FILLETS/CHAMFER .06  
 DE-BURR ALL PARTS

INTERPRET GEOMETRIC  
 TOLERANCING PER: ASME Y14.5

MATERIAL

FINISH

DO NOT SCALE DRAWING

NAME	DATE	 <b>LASERLINC, INC.</b> PHONE: 888-707-4892 INFO@LASERLINC.COM WWW.LASERLINC.COM
DRAWN BY: EMM	11/4/2020	
TITLE:		0222-0001-21 AXION222 V-BLOCK FIXTURE, WHITE DELRIN OVERALLS
SIZE	DWG. NO.	REV
<b>B</b>	0222-0001-21	<b>A</b>
SCALE: 1:2		SHEET 4 OF 7

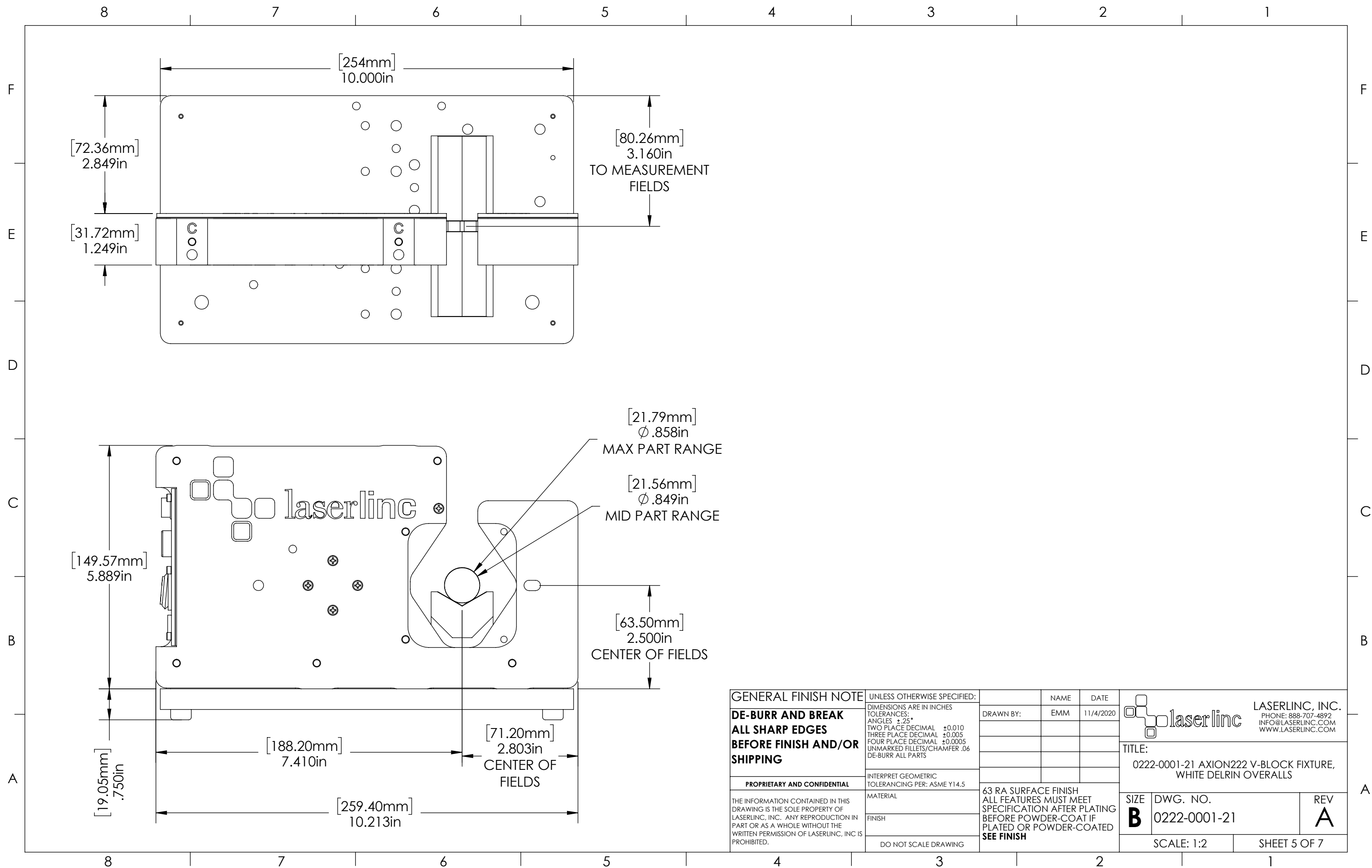

<b>GENERAL FINISH NOTE</b>	UNLESS OTHERWISE SPECIFIED:	NAME	DATE	 <b>LASERLINC, INC.</b> PHONE: 888-707-4892 INFO@LASERLINC.COM WWW.LASERLINC.COM
	<b>DE-BURR AND BREAK</b> <b>ALL SHARP EDGES</b> <b>BEFORE FINISH AND/OR SHIPPING</b>	DIMENSIONS ARE IN INCHES TOLERANCES: ANGLES $\pm$ .25° TWO PLACE DECIMAL $\pm$ 0.010 THREE PLACE DECIMAL $\pm$ 0.005 FOUR PLACE DECIMAL $\pm$ 0.0005 UNMARKED FILLETS/CHAMFER .06 DE-BURR ALL PARTS	DRAWN BY:	
<b>PROPRIETARY AND CONFIDENTIAL</b>	INTERPRET GEOMETRIC TOLERANCING PER: ASME Y14.5	TITLE: 0222-0001-21 AXION222 V-BLOCK FIXTURE, WHITE DELRIN OVERALLS		
THE INFORMATION CONTAINED IN THIS DRAWING IS THE SOLE PROPERTY OF LASERLINC, INC. ANY REPRODUCTION IN PART OR AS A WHOLE WITHOUT THE WRITTEN PERMISSION OF LASERLINC, INC. IS PROHIBITED.	MATERIAL	63 RA SURFACE FINISH ALL FEATURES MUST MEET SPECIFICATION AFTER PLATING BEFORE POWDER-COAT IF PLATED OR POWDER-COATED <b>SEE FINISH</b>		
	FINISH	SIZE	DWG. NO.	REV
	DO NOT SCALE DRAWING	<b>B</b>	0222-0001-21	<b>A</b>
		SCALE: 1:2		SHEET 5 OF 7

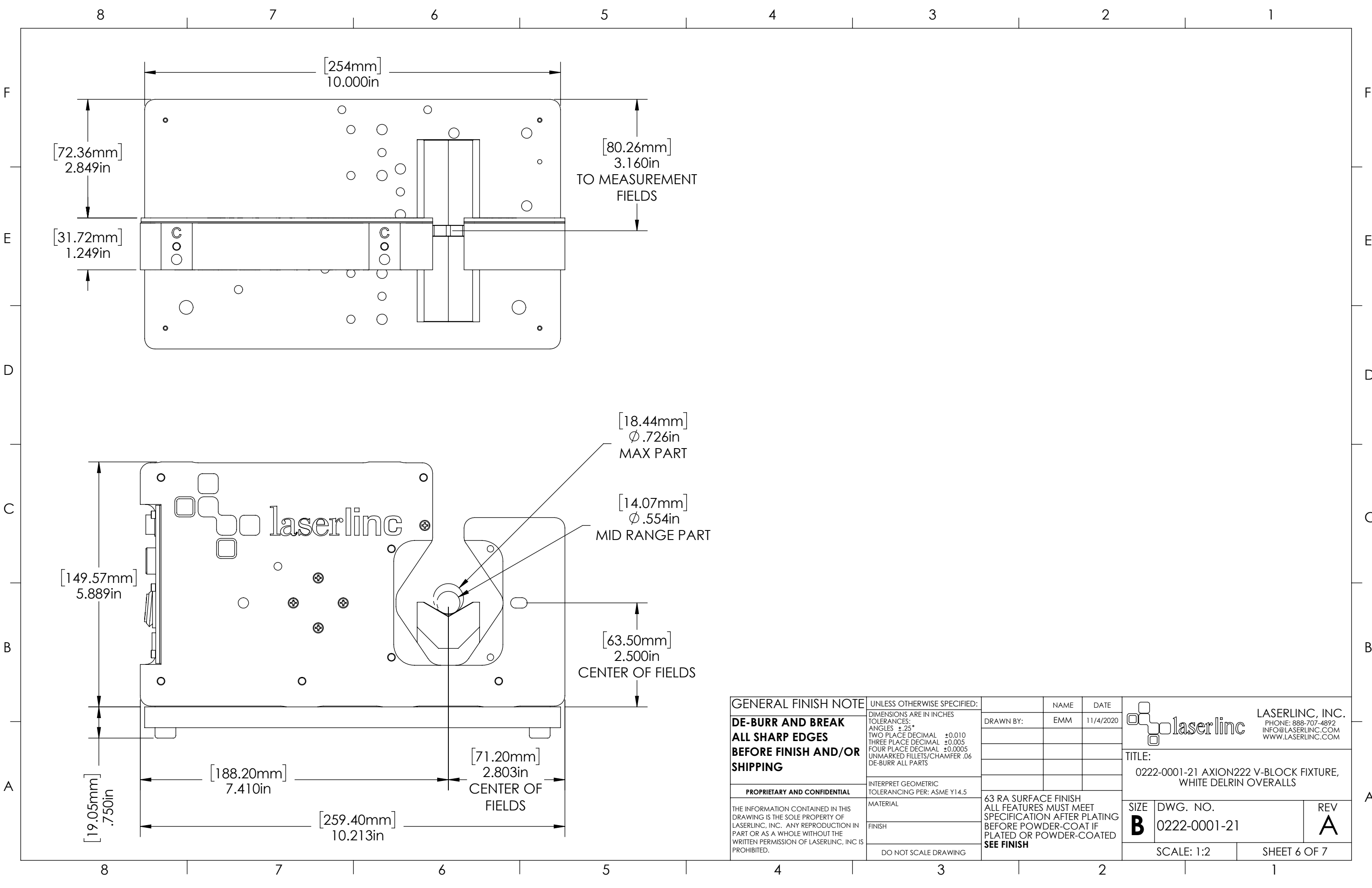

**GENERAL FINISH NOTE**  
**DE-BURR AND BREAK**  
**ALL SHARP EDGES**  
**BEFORE FINISH AND/OR**  
**SHIPPING**

UNLESS OTHERWISE SPECIFIED:  
 DIMENSIONS ARE IN INCHES  
 TOLERANCES:  
 ANGLES ±.25°  
 TWO PLACE DECIMAL ±0.010  
 THREE PLACE DECIMAL ±0.005  
 FOUR PLACE DECIMAL ±0.0005  
 UNMARKED FILLETS/CHAMFER .06  
 DE-BURR ALL PARTS

INTERPRET GEOMETRIC  
 TOLERANCING PER: ASME Y14.5

MATERIAL

FINISH

DO NOT SCALE DRAWING

NAME	DATE	
EMM	11/4/2020	
DRAWN BY:		
TITLE:		
0222-0001-21 AXION222 V-BLOCK FIXTURE, WHITE DELRIN OVERALLS		
SIZE	DWG. NO.	REV
<b>B</b>	0222-0001-21	<b>A</b>
SCALE: 1:2		SHEET 6 OF 7



**PROPRIETARY AND CONFIDENTIAL**

THE INFORMATION CONTAINED IN THIS DRAWING IS THE SOLE PROPERTY OF LASERLINC, INC. ANY REPRODUCTION IN PART OR AS A WHOLE WITHOUT THE WRITTEN PERMISSION OF LASERLINC, INC. IS PROHIBITED.

63 RA SURFACE FINISH  
 ALL FEATURES MUST MEET SPECIFICATION AFTER PLATING BEFORE POWDER-COAT IF PLATED OR POWDER-COATED  
**SEE FINISH**

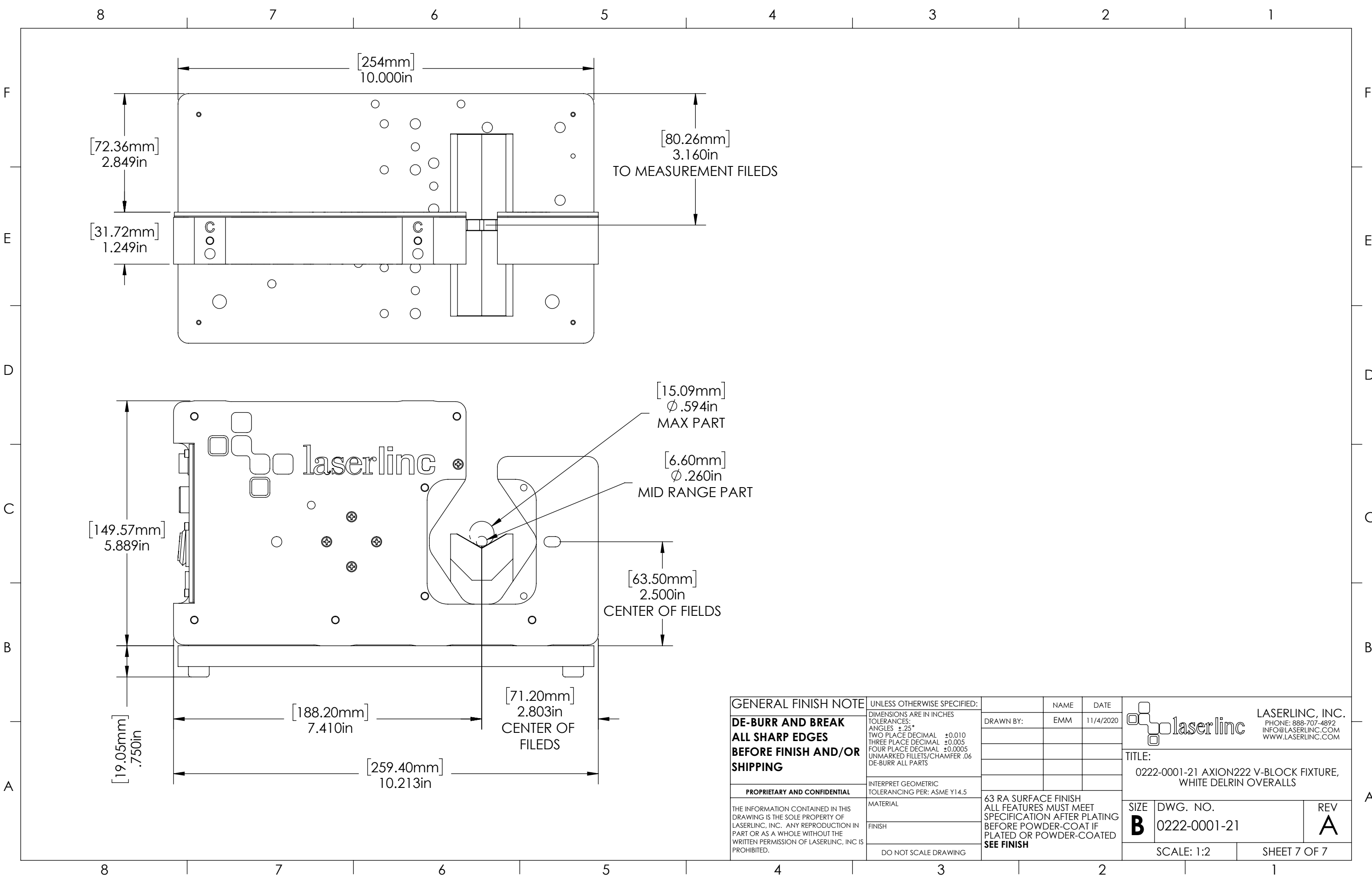

**GENERAL FINISH NOTE**  
**DE-BURR AND BREAK**  
**ALL SHARP EDGES**  
**BEFORE FINISH AND/OR**  
**SHIPPING**

**PROPRIETARY AND CONFIDENTIAL**

THE INFORMATION CONTAINED IN THIS DRAWING IS THE SOLE PROPERTY OF LASERLINC, INC. ANY REPRODUCTION IN PART OR AS A WHOLE WITHOUT THE WRITTEN PERMISSION OF LASERLINC, INC. IS PROHIBITED.

UNLESS OTHERWISE SPECIFIED:  
 DIMENSIONS ARE IN INCHES  
 TOLERANCES:  
 ANGLES  $\pm .25^\circ$   
 TWO PLACE DECIMAL  $\pm 0.010$   
 THREE PLACE DECIMAL  $\pm 0.005$   
 FOUR PLACE DECIMAL  $\pm 0.0005$   
 UNMARKED FILLETS/CHAMFER .06  
 DE-BURR ALL PARTS

INTERPRET GEOMETRIC TOLERANCING PER: ASME Y14.5

MATERIAL

FINISH

DO NOT SCALE DRAWING

NAME	DATE
EMM	11/4/2020

63 RA SURFACE FINISH  
 ALL FEATURES MUST MEET SPECIFICATION AFTER PLATING BEFORE POWDER-COAT IF PLATED OR POWDER-COATED  
**SEE FINISH**

		<b>LASERLINC, INC.</b> PHONE: 888-707-4892 INFO@LASERLINC.COM WWW.LASERLINC.COM	
<b>TITLE:</b> 0222-0001-21 AXION222 V-BLOCK FIXTURE, WHITE DELRIN OVERALLS			
<b>SIZE</b> <b>B</b>	<b>DWG. NO.</b> 0222-0001-21	<b>REV</b> <b>A</b>	
SCALE: 1:2		SHEET 7 OF 7	