

8

7

6

5

4

3

2

1

REVISIONS				
ZONE	REV.	DESCRIPTION	DATE	APPROVED
	A	Check-In	10/23/2014	MAM

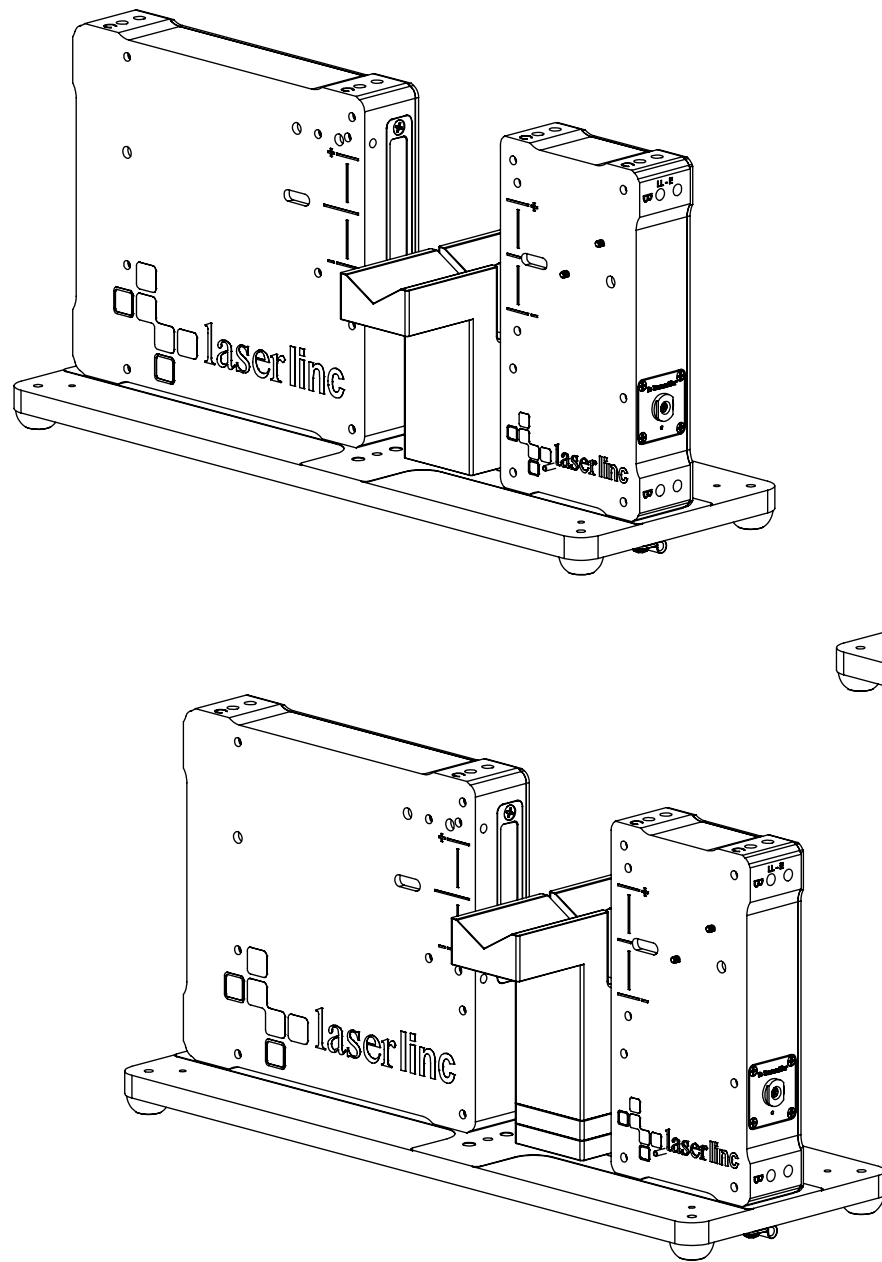

AXION160 V-BLOCK FIXTURE, STAINLESS STEEL OVERALLS

INDEX

- (1) COVER PAGE
- (2) NO RISER FIXTURE DIMENSIONS
- (3) NO RISER MOUNTED DIMENSIONS
- (4) 1 RISER FIXTURE DIMENSIONS
- (5) 1 RISER MOUNTED DIMENSIONS
- (6) 2 RISER FIXTURE DIMENSIONS
- (7) 2 RISER MOUNTED DIMENSIONS

GENERAL FINISH NOTE		UNLESS OTHERWISE SPECIFIED:		NAME	DATE
DE-BURR AND BREAK ALL SHARP EDGES BEFORE FINISH AND/OR SHIPPING		DIMENSIONS ARE IN INCHES TOLERANCES: ANGLES ±.25° TWO PLACE DECIMAL ±0.010 THREE PLACE DECIMAL ±0.005 FOUR PLACE DECIMAL ±0.0005 UNMARKED FILLETS/CHAMFER .06 DE-BURR ALL PARTS		DRAWN BY:	EMM 11/10/2020
PROPRIETARY AND CONFIDENTIAL		INTERPRET GEOMETRIC TOLERANCING PER: ASME Y14.5			
THE INFORMATION CONTAINED IN THIS DRAWING IS THE SOLE PROPERTY OF LASERLINC, INC. ANY REPRODUCTION IN PART OR AS A WHOLE WITHOUT THE WRITTEN PERMISSION OF LASERLINC, INC. IS PROHIBITED.		MATERIAL		63 RA SURFACE FINISH ALL FEATURES MUST MEET SPECIFICATION AFTER PLATING BEFORE POWDER-COAT IF PLATED OR POWDER-COATED SEE FINISH	
		FINISH			
DO NOT SCALE DRAWING				LASERLINC, INC. PHONE: 888-707-4892 INFO@LASERLINC.COM WWW.LASERLINC.COM	
				TITLE: 0160-0000-21 AXION160 V-BLOCK FIXTURE, STAINLESS STEEL OVERALLS	
				SIZE B	DWG. NO. 0160-0000-21
				REV A	
				SCALE: 1:4	SHEET 1 OF 7

8

7

6

5

4

3

2

1

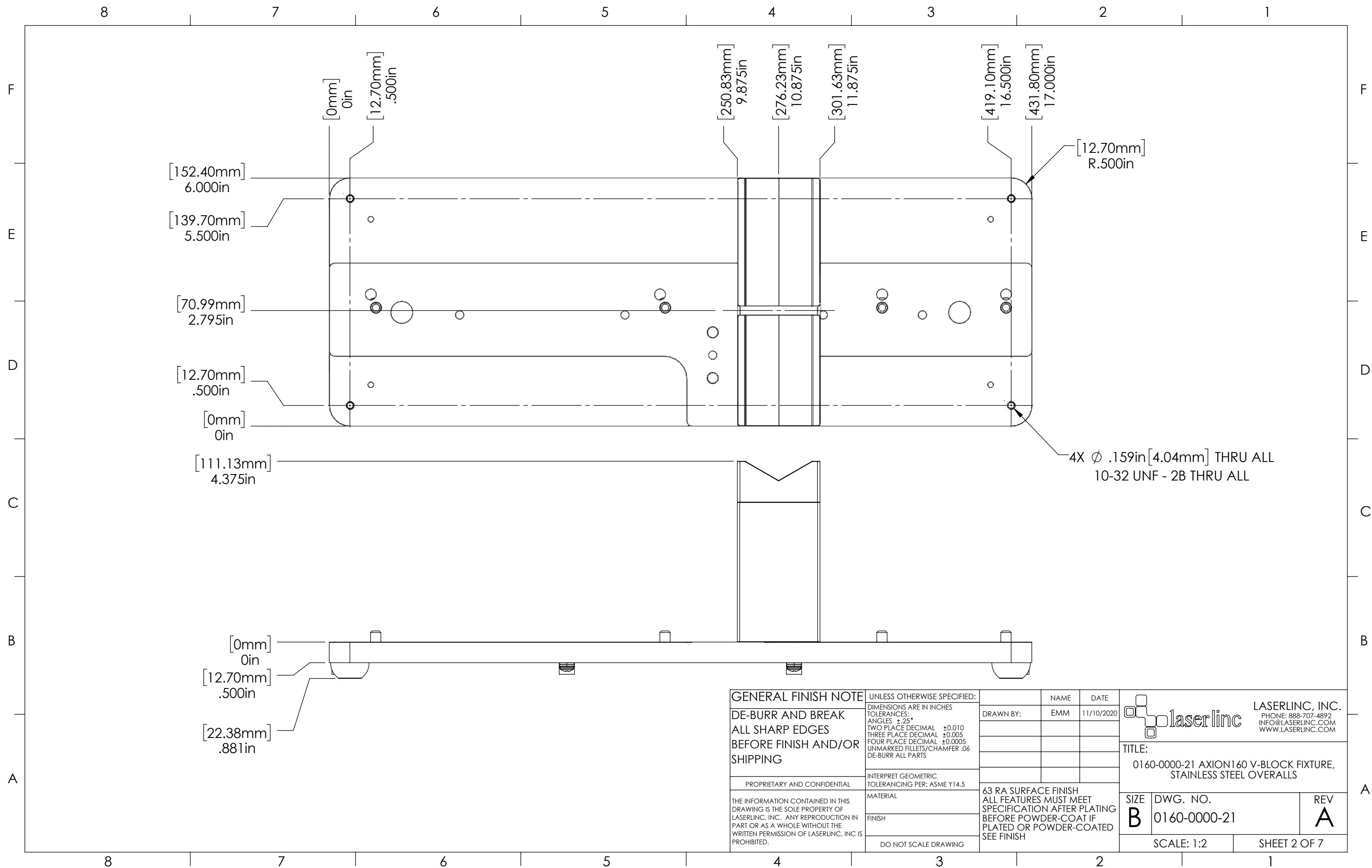

[152.40mm]
6.000in

[139.70mm]
5.500in

[70.99mm]
2.795in

[12.70mm]
.500in

[0mm]
0in

[111.13mm]
4.375in

[0mm]
0in

[12.70mm]
.500in

[22.38mm]
.881in

[0mm]
0in

[12.70mm]
.500in

[250.83mm]
9.875in

[276.23mm]
10.875in

[301.63mm]
11.875in

[419.10mm]
16.500in

[431.80mm]
17.000in

[12.70mm]
R.500in

4X Ø .159in [4.04mm] THRU ALL
10-32 UNF - 2B THRU ALL

GENERAL FINISH NOTE DE-BURR AND BREAK ALL SHARP EDGES BEFORE FINISH AND/OR SHIPPING PROPRIETARY AND CONFIDENTIAL THE INFORMATION CONTAINED IN THIS DRAWING IS THE SOLE PROPERTY OF LASERLINC, INC. ANY REPRODUCTION IN PART OR AS A WHOLE WITHOUT THE WRITTEN PERMISSION OF LASERLINC, INC IS PROHIBITED.	UNLESS OTHERWISE SPECIFIED: DIMENSIONS ARE IN INCHES TOLERANCES: ANGLES ±.25 TWO PLACE DECIMAL ±0.010 THREE PLACE DECIMAL ±0.005 FOUR PLACE DECIMAL ±0.0005 UNMARKED FILLETS/CHAMFER .06 DE-BURR ALL PARTS	NAME DATE DRAWN BY: EMM 11/10/2020	LASERLINC, INC. PHONE: 888-707-4892 INFO@LASERLINC.COM WWW.LASERLINC.COM		
	INTERPRET GEOMETRIC TOLERANCING PER: ASME Y14.5	TITLE: 0160-0000-21 AXION160 V-BLOCK FIXTURE, STAINLESS STEEL OVERALLS			
	MATERIAL FINISH DO NOT SCALE DRAWING	63 RA SURFACE FINISH ALL FEATURES MUST MEET SPECIFICATION AFTER PLATING BEFORE POWDER-COAT IF PLATED OR POWDER-COATED SEE FINISH	SIZE B	DWG. NO. 0160-0000-21	REV A
			SCALE: 1:2	SHEET 2 OF 7	

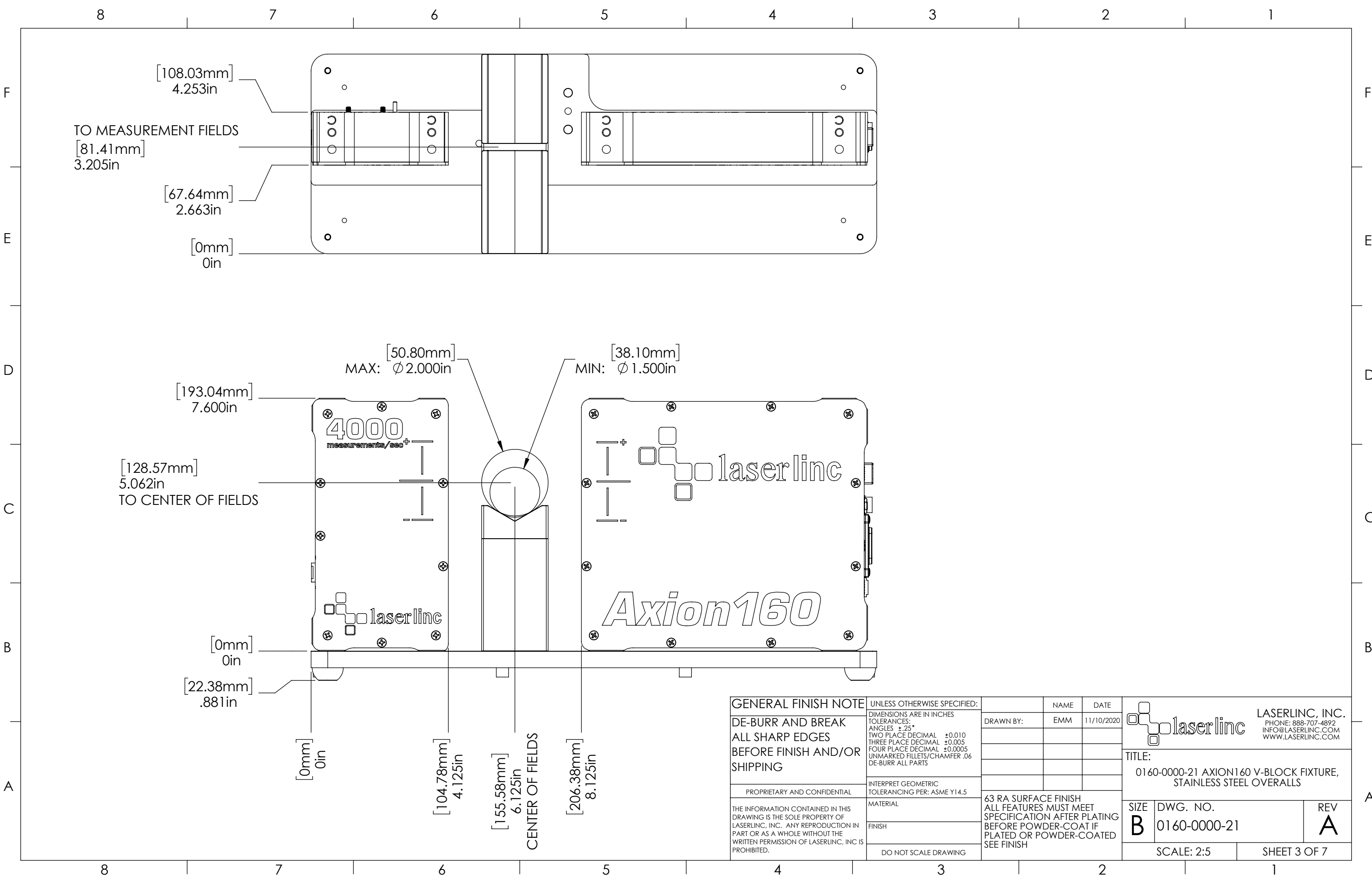

GENERAL FINISH NOTE
 DE-BURR AND BREAK
 ALL SHARP EDGES
 BEFORE FINISH AND/OR
 SHIPPING

PROPRIETARY AND CONFIDENTIAL

THE INFORMATION CONTAINED IN THIS
 DRAWING IS THE SOLE PROPERTY OF
 LASERLINC, INC. ANY REPRODUCTION IN
 PART OR AS A WHOLE WITHOUT THE
 WRITTEN PERMISSION OF LASERLINC, INC. IS
 PROHIBITED.

UNLESS OTHERWISE SPECIFIED:
 DIMENSIONS ARE IN INCHES
 TOLERANCES:
 ANGLES ±.25°
 TWO PLACE DECIMAL ±0.010
 THREE PLACE DECIMAL ±0.005
 FOUR PLACE DECIMAL ±0.0005
 UNMARKED FILLETS/CHAMFER .06
 DE-BURR ALL PARTS

INTERPRET GEOMETRIC
 TOLERANCING PER: ASME Y14.5

MATERIAL

FINISH

DO NOT SCALE DRAWING

NAME	DATE
EMM	11/10/2020

63 RA SURFACE FINISH
 ALL FEATURES MUST MEET
 SPECIFICATION AFTER PLATING
 BEFORE POWDER-COAT IF
 PLATED OR POWDER-COATED
 SEE FINISH

laserline LASERLINC, INC.
 PHONE: 888-707-4892
 INFO@LASERLINC.COM
 WWW.LASERLINC.COM

TITLE:
 0160-0000-21 AXION160 V-BLOCK FIXTURE,
 STAINLESS STEEL OVERALLS

SIZE	DWG. NO.	REV
B	0160-0000-21	A

SCALE: 2:5 SHEET 3 OF 7

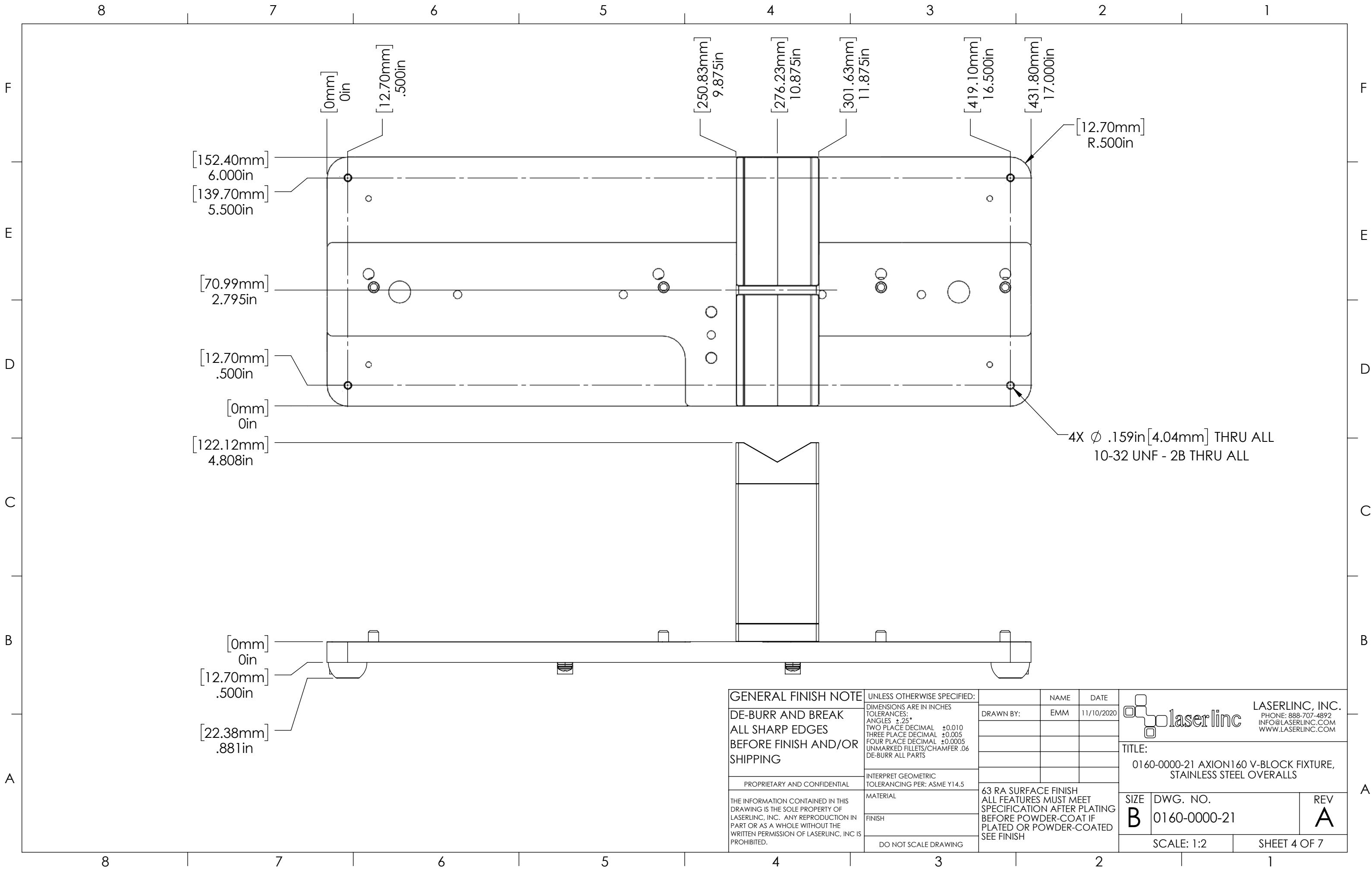

[152.40mm]
6.000in
[139.70mm]
5.500in

[70.99mm]
2.795in

[12.70mm]
.500in

[0mm]
0in

[122.12mm]
4.808in

[0mm]
0in

[12.70mm]
.500in

[22.38mm]
.881in

[0mm]
0in
[12.70mm]
.500in

[250.83mm]
9.875in

[276.23mm]
10.875in

[301.63mm]
11.875in

[419.10mm]
16.500in

[431.80mm]
17.000in

[12.70mm]
R.500in

4X ϕ .159in [4.04mm] THRU ALL
10-32 UNF - 2B THRU ALL

GENERAL FINISH NOTE
DE-BURR AND BREAK
ALL SHARP EDGES
BEFORE FINISH AND/OR
SHIPPING

PROPRIETARY AND CONFIDENTIAL
THE INFORMATION CONTAINED IN THIS
DRAWING IS THE SOLE PROPERTY OF
LASERLINC, INC. ANY REPRODUCTION IN
PART OR AS A WHOLE WITHOUT THE
WRITTEN PERMISSION OF LASERLINC, INC IS
PROHIBITED.

UNLESS OTHERWISE SPECIFIED:
DIMENSIONS ARE IN INCHES
TOLERANCES:
ANGLES \pm .25
TWO PLACE DECIMAL \pm 0.010
THREE PLACE DECIMAL \pm 0.005
FOUR PLACE DECIMAL \pm 0.0005
UNMARKED FILLETS/CHAMFER .06
DE-BURR ALL PARTS

INTERPRET GEOMETRIC
TOLERANCING PER: ASME Y14.5

MATERIAL

FINISH

DO NOT SCALE DRAWING

NAME	DATE
EMM	11/10/2020

63 RA SURFACE FINISH
ALL FEATURES MUST MEET
SPECIFICATION AFTER PLATING
BEFORE POWDER-COAT IF
PLATED OR POWDER-COATED
SEE FINISH

laserlinc LASERLINC, INC.
PHONE: 888-707-4892
INFO@LASERLINC.COM
WWW.LASERLINC.COM

TITLE:
0160-0000-21 AXION160 V-BLOCK FIXTURE,
STAINLESS STEEL OVERALLS

SIZE	DWG. NO.	REV
B	0160-0000-21	A

SCALE: 1:2 SHEET 4 OF 7

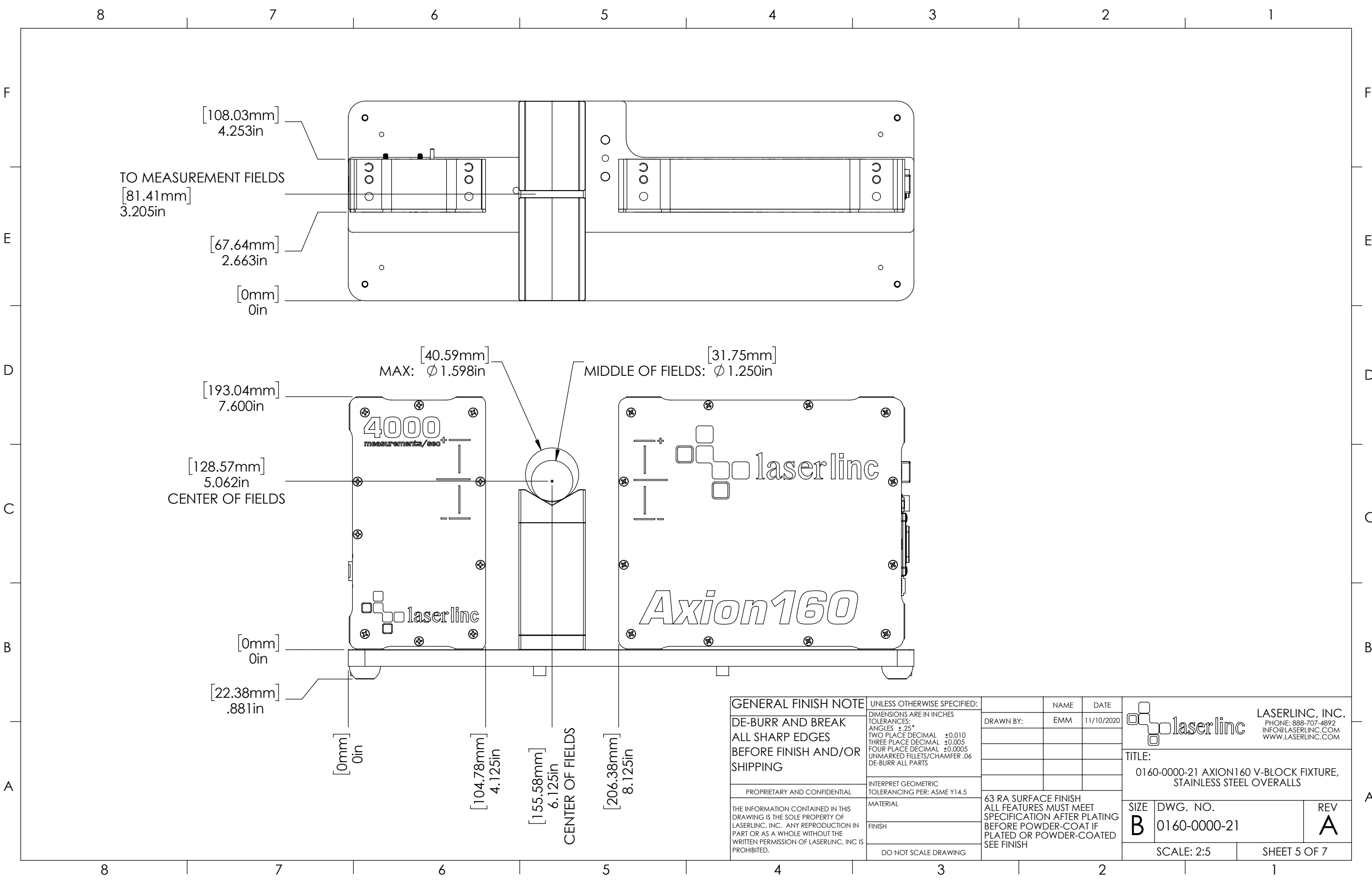

[108.03mm]
4.253in

TO MEASUREMENT FIELDS
[81.41mm]
3.205in

[67.64mm]
2.663in

[0mm]
0in

[40.59mm]
MAX: Ø 1.598in

[31.75mm]
MIDDLE OF FIELDS: Ø 1.250in

[193.04mm]
7.600in

[128.57mm]
5.062in
CENTER OF FIELDS

[0mm]
0in

[22.38mm]
.881in

[0mm]
0in

[104.78mm]
4.125in

[155.58mm]
6.125in
CENTER OF FIELDS

[206.38mm]
8.125in

GENERAL FINISH NOTE DE-BURR AND BREAK ALL SHARP EDGES BEFORE FINISH AND/OR SHIPPING	UNLESS OTHERWISE SPECIFIED:	NAME	DATE	 LASERLINC, INC. PHONE: 888-707-4892 INFO@LASERLINC.COM WWW.LASERLINC.COM
	DIMENSIONS ARE IN INCHES TOLERANCES: ANGLES ±.25° TWO PLACE DECIMAL ±0.010 THREE PLACE DECIMAL ±0.005 FOUR PLACE DECIMAL ±0.0005 UNMARKED FILLETS/CHAMFER .06 DE-BURR ALL PARTS	DRAWN BY:	EMM	
PROPRIETARY AND CONFIDENTIAL	INTERPRET GEOMETRIC TOLERANCING PER: ASME Y14.5			TITLE: 0160-0000-21 AXION160 V-BLOCK FIXTURE, STAINLESS STEEL OVERALLS
THE INFORMATION CONTAINED IN THIS DRAWING IS THE SOLE PROPERTY OF LASERLINC, INC. ANY REPRODUCTION IN PART OR AS A WHOLE WITHOUT THE WRITTEN PERMISSION OF LASERLINC, INC. IS PROHIBITED.	MATERIAL	63 RA SURFACE FINISH ALL FEATURES MUST MEET SPECIFICATION AFTER PLATING BEFORE POWDER-COAT IF PLATED OR POWDER-COATED SEE FINISH		SIZE B DWG. NO. 0160-0000-21 REV A
	FINISH			SCALE: 2:5 SHEET 5 OF 7
	DO NOT SCALE DRAWING			

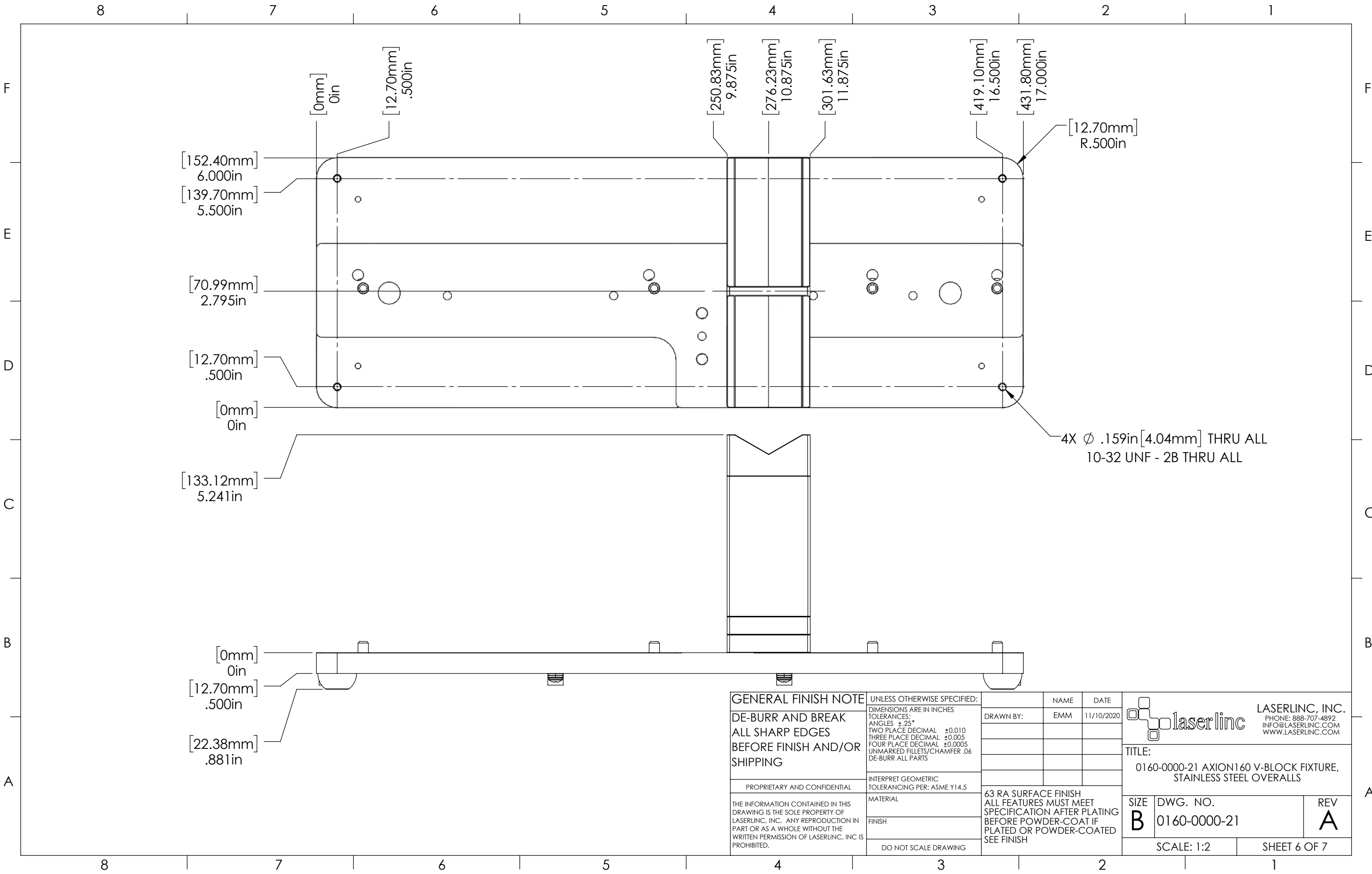

GENERAL FINISH NOTE
 DE-BURR AND BREAK
 ALL SHARP EDGES
 BEFORE FINISH AND/OR
 SHIPPING

PROPRIETARY AND CONFIDENTIAL
 THE INFORMATION CONTAINED IN THIS
 DRAWING IS THE SOLE PROPERTY OF
 LASERLINC, INC. ANY REPRODUCTION IN
 PART OR AS A WHOLE WITHOUT THE
 WRITTEN PERMISSION OF LASERLINC, INC. IS
 PROHIBITED.

UNLESS OTHERWISE SPECIFIED:
 DIMENSIONS ARE IN INCHES
 TOLERANCES:
 ANGLES \pm .25
 TWO PLACE DECIMAL \pm 0.010
 THREE PLACE DECIMAL \pm 0.005
 FOUR PLACE DECIMAL \pm 0.0005
 UNMARKED FILLETS/CHAMFER .06
 DE-BURR ALL PARTS

INTERPRET GEOMETRIC
 TOLERANCING PER: ASME Y14.5
 MATERIAL
 FINISH
 DO NOT SCALE DRAWING

NAME	DATE
EMM	11/10/2020

63 RA SURFACE FINISH
 ALL FEATURES MUST MEET
 SPECIFICATION AFTER PLATING
 BEFORE POWDER-COAT IF
 PLATED OR POWDER-COATED
 SEE FINISH

LASERLINC, INC.
 PHONE: 888-707-4892
 INFO@LASERLINC.COM
 WWW.LASERLINC.COM

TITLE:
 0160-0000-21 AXION160 V-BLOCK FIXTURE,
 STAINLESS STEEL OVERALLS

SIZE	DWG. NO.	REV
B	0160-0000-21	A

SCALE: 1:2 SHEET 6 OF 7

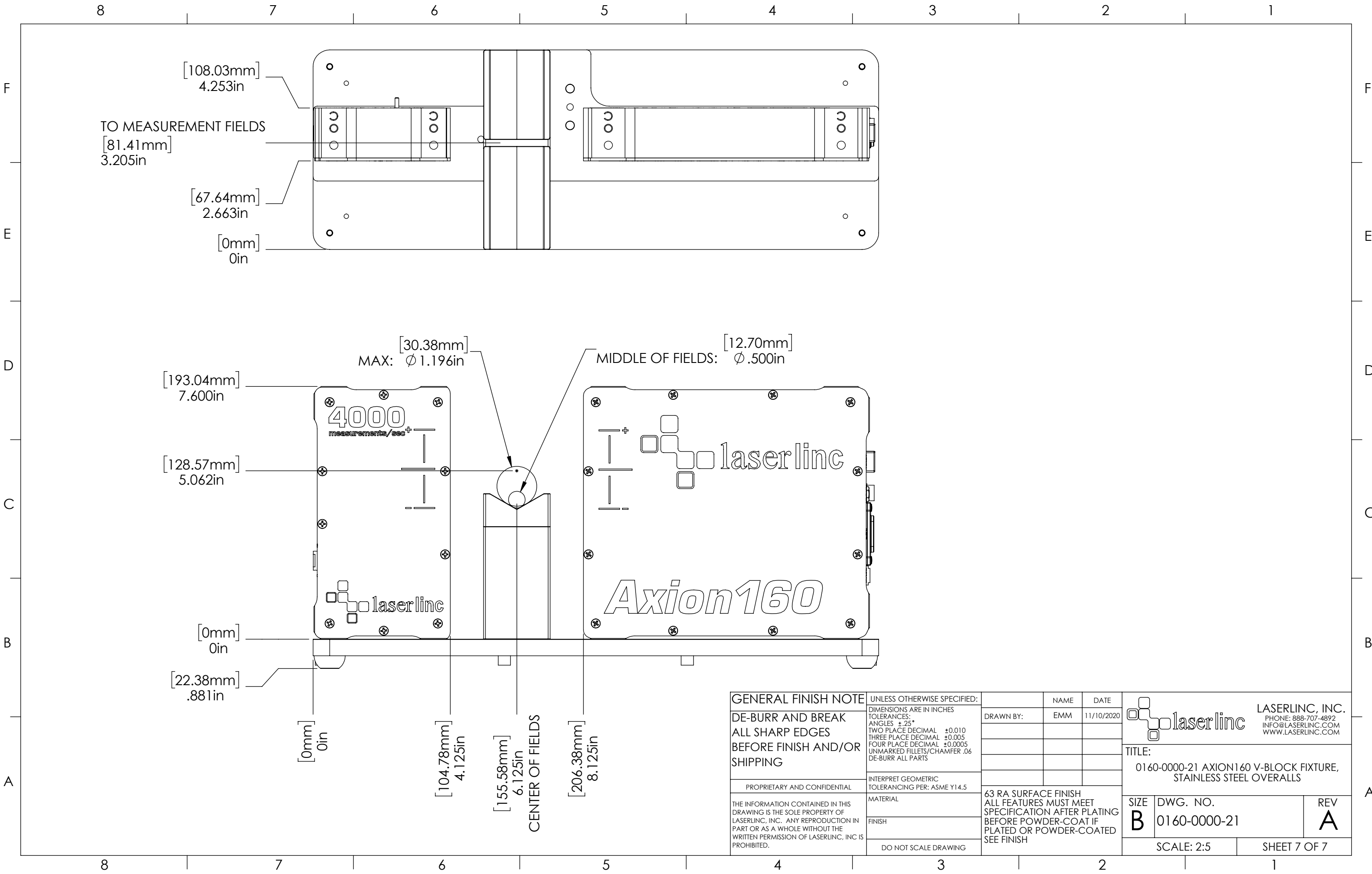

GENERAL FINISH NOTE
 DE-BURR AND BREAK
 ALL SHARP EDGES
 BEFORE FINISH AND/OR
 SHIPPING

PROPRIETARY AND CONFIDENTIAL

THE INFORMATION CONTAINED IN THIS
 DRAWING IS THE SOLE PROPERTY OF
 LASERLINC, INC. ANY REPRODUCTION IN
 PART OR AS A WHOLE WITHOUT THE
 WRITTEN PERMISSION OF LASERLINC, INC. IS
 PROHIBITED.

UNLESS OTHERWISE SPECIFIED:
 DIMENSIONS ARE IN INCHES
 TOLERANCES:
 ANGLES ±.25°
 TWO PLACE DECIMAL ±0.010
 THREE PLACE DECIMAL ±0.005
 FOUR PLACE DECIMAL ±0.0005
 UNMARKED FILLETS/CHAMFER .06
 DE-BURR ALL PARTS

INTERPRET GEOMETRIC
 TOLERANCING PER: ASME Y14.5

MATERIAL

FINISH

DO NOT SCALE DRAWING

NAME	DATE
EMM	11/10/2020

63 RA SURFACE FINISH
 ALL FEATURES MUST MEET
 SPECIFICATION AFTER PLATING
 BEFORE POWDER-COAT IF
 PLATED OR POWDER-COATED
 SEE FINISH

laserlinc LASERLINC, INC.
 PHONE: 888-707-4892
 INFO@LASERLINC.COM
 WWW.LASERLINC.COM

TITLE:
 0160-0000-21 AXION160 V-BLOCK FIXTURE,
 STAINLESS STEEL OVERALLS

SIZE B	DWG. NO. 0160-0000-21	REV A
------------------	--------------------------	-----------------

SCALE: 2:5 SHEET 7 OF 7